

STATE OF NORTH CAROLINA
DEPARTMENT OF TRANSPORTATION
HIGHWAY DIVISION 12

ID/IQ - SMALL BUSINESS ENTERPRISE PROPOSAL

DATE AND TIME OF BID OPENING: November 26, 2024 AT 2:00 PM

CONTRACT ID: D12-12143762

WBS ELEMENT NO: 12.100211, 12.101811, 12.102311, 12.103611, 12.104911, 12.105511,
12.200211, 12.201811, 12.202311, 12.203611, 12.204911 & 12.205511

FEDERAL AID NO.: STATE FUNDED

COUNTY(S): ALEXANDER, CATAWBA, CLEVELAND, GASTON, IREDELL &
LINCOLN

TIP NO.: NONE

MILES: N/A

ROUTE NO.: VARIOUS INTERSTATE, PRIMARY & SECONDARY ROADS

LOCATION: DIVISIONWIDE

TYPE OF WORK: ON-CALL TRENCHLESS PIPE INSTALLATION (BORE & JACK)

NOTICE:

UNDER THE PROVISIONS OF THIS PROGRAM, A N.C. GENERAL CONTRACTOR'S LICENSE IS NOT REQUIRED AND CONTRACT PAYMENT AND CONTRACT PERFORMANCE BONDS IS NOT REQUIRED. BIDDERS SHALL ALSO COMPLY WITH ALL OTHER APPLICABLE LAWS, INCLUDING BUT NOT LIMITED TO, THOSE REGULATING THE PRACTICES OF ELECTRICAL, PLUMBING, HEATING AND AIR CONDITIONING AND REFRIGERATION CONTRACTING AS CONTAINED IN CHAPTER 87 OF THE GENERAL STATUTES OF NORTH CAROLINA.

THIS IS A ROADWAY PROJECT.

BID BOND IS NOT REQUIRED.

NAME OF BIDDER

ADDRESS OF BIDDER

**PROPOSAL FOR THE CONSTRUCTION OF
CONTRACT No. D12-12143762 IN DIVISION 12
DEPARTMENT OF TRANSPORTATION,
RALEIGH, NORTH CAROLINA**

The Bidder has carefully examined the location of the proposed work to be known as Contract No. **D12-12143762**; has carefully examined the plans and specifications, which are acknowledged to be part of the proposal, the special provisions, the proposal, the form of contract; and thoroughly understands the stipulations, requirements and provisions. The undersigned bidder agrees to be bound upon his execution of the bid and subsequent award to him by the Department of Transportation in accordance with this proposal. Payment and performance bonds are not required on this project. The undersigned Bidder further agrees to provide all necessary machinery, tools, labor, and other means of construction; and to do all the work and to furnish all materials, except as otherwise noted, necessary to perform and complete the said contract in accordance with the *2024 Standard Specifications for Roads and Structures* by the dates(s) specified in the Project Special Provisions and in accordance with the requirements of the Engineer, and at the unit or lump sum prices, as the case may be, for the various items given on the sheets contained herein.

The Bidder shall provide and furnish all the materials, machinery, implements, appliances and tools, and perform the work and required labor to construct and complete Contract No. **D12-12143762** in **Alexander, Catawba, Cleveland, Gaston, Iredell & Lincoln Counties**, for the unit or lump sum prices, as the case may be, bid by the Bidder in his bid and according to the proposal, plans, and specifications prepared by said Department, which proposal, plans, and specifications show the details covering this project, and hereby become a part of this contract.

The published volume entitled *North Carolina Department of Transportation, Raleigh, Standard Specifications for Roads and Structures, January 2024* with all amendments and supplements thereto, is by reference incorporated into and made a part of this contract; that, except as herein modified, all the construction and work included in this contract is to be done in accordance with the specifications contained in said volume, and amendments and supplements thereto, under the direction of the Engineer.

If the proposal is accepted and the award is made, the contract is valid only when signed either by the Contract Officer or such other person as may be designated by the Secretary to sign for the Department of Transportation. The conditions and provisions herein cannot be changed except over the signature of the said Contract Officer or Division Engineer.

The quantities shown in the itemized proposal for the project are considered to be approximate only and are given as the basis for comparison of bids. The Department of Transportation may increase or decrease the quantity of any item or portion of the work as may be deemed necessary or expedient.

An increase or decrease in the quantity of an item will not be regarded as sufficient ground for an increase or decrease in the unit prices, nor in the time allowed for the completion of the work, except as provided for the contract.

TABLE OF CONTENTS

**COVER SHEET
PROPOSAL SHEET**

PROJECT SPECIAL PROVISIONS

AWARD OF CONTRACT – SMALL BUSINESS ENTERPRISE PROGRAM.....G-1
 INTERESTED PARTIES LIST NOT REQUIRED:G-1
 BOND REQUIREMENTS – No Bonds Required.....G-1
 CONTRACT TIME FOR ID/IQ:.....G-2
 WORK ORDER ASSIGNMENT (SINGLE AWARDS) FOR ID/IQ:.....G-2
 BONDING REQUIREMENTS FOR ID/IQ:G-3
 MOBILIZATION AND LIQUIDATED DAMAGES FOR ID/IQ:G-3
 EMERGENCY MOBILIZATION FOR ID/IQ:G-4
 RENEWAL OF CONTRACT (CPI PRICE ADJUSTMENT) FOR ID/IQ:G-4
 DISPUTE RESOLUTION PROCESS FOR ID/IQ:G-5
 INTERMEDIATE CONTRACT TIME NUMBER 1 AND LIQUIDATED DAMAGES:.....G-5
 NO MAJOR CONTRACT ITEMS:.....G-7
 NO SPECIALTY ITEMS:.....G-7
 FUEL PRICE ADJUSTMENT PAPER BID:G-7
 SCHEDULE OF ESTIMATED COMPLETION PROGRESS:.....G-8
 SMALL BUSINESS ENTERPRISE (MULTI-YEAR MAINTENANCE CONTRACTS):G-9
 RESTRICTIONS ON ITS EQUIPMENT AND SERVICES:G-9
 USE OF UNMANNED AIRCRAFT SYSTEM (UAS):.....G-9
 EQUIPMENT IDLING GUIDELINES:G-10
 OUTSOURCING OUTSIDE THE USA:G-10

ROADWAYR-1

STANDARD SPECIAL PROVISIONS

AVAILABILITY OF FUNDS – TERMINATION OF CONTRACTS SSP-1

SIGNATURE SHEETS AND FORMS..... S-1
BID/PAY ITEM SHEETS..... T-1
DOT EXECUTION SHEET U-1

WELDING DETAILS..... V-1

INSTRUCTIONS TO BIDDERS**PLEASE READ ALL INSTRUCTIONS CAREFULLY
BEFORE PREPARING AND SUBMITTING YOUR BID.**

All bids shall be prepared and submitted in accordance with the following requirements. Failure to comply with any requirement may cause the bid to be considered irregular and may be grounds for rejection of the bid.

TRADITIONAL PAPER BIDS:

1. Download the entire proposal from the Connect NCDOT website and return the entire proposal with your bid.
2. In accordance with Article 102-3 of the *Standard Specifications*, registration on the Interested Parties List is required unless SP1 G02 Interested Parties List Not Required provision is included in the proposal.
3. All entries on the itemized proposal sheet (bid form) shall be written in ink or typed.
4. The Bidder shall submit a unit price for every item on the itemized proposal sheet. The unit prices for the various contract items shall be written in figures. Unit prices shall be rounded off by the Bidder to contain no more than FOUR decimal places.
5. An amount bid shall be entered on the itemized proposal sheet for every item. The amount bid for each item shall be determined by multiplying each unit bid by the quantity for that item, and shall be written in figures in the "Amount" column of the form.
6. The total amount bid shall be written in figures in the proper place on the bid form. The total amount bid shall be determined by adding the amounts bid for each item.
7. Changes to any entry shall be made by marking through the entry in ink and making the correct entry adjacent thereto in ink. A representative of the Bidder shall initial the change in ink. Do not use correction fluid, correction tape or similar product to make corrections.
8. The bid shall be properly executed on the included **Execution of Bid – Non-collusion, Debarment and Gift Ban Certification** form. All bids shall show the following information:
 - a. Name of corporation, partnership, Limited Liability Company, joint venture, individual or firm, submitting bid.
Corporations that have a corporate seal shall include it on the bid, otherwise write your corporations name in the seal location.
 - b. Name of individual or representative submitting bid and position or title held on behalf of the bidder.
 - c. Name, signature, and position or title of witness.
9. The bid shall not contain any unauthorized additions, deletions, or conditional bids.
10. The Bidder shall not add any provision reserving the right to accept or reject an award, or to enter into a contract pursuant to an award.
11. **THE PROPOSAL WITH THE ITEMIZED PROPOSAL SHEET ATTACHED SHALL BE PLACED IN A SEALED ENVELOPE AND SHALL BE DELIVERED TO AND RECEIVED IN THE NCDOT DIVISION 12 OFFICE, LOCATED AT 1710 E. MARION ST., BY 2:00 PM ON, NOVEMBER 26, 2024.**
12. The sealed bid must display the following statement on the front of the sealed envelope:

QUOTATION FOR: TRENCHLESS PIPE INSTALLATION (BORE & JACK) IN

DIVISION 12, TO BE OPENED AT 2:00 PM ON, NOVEMBER 26, 2024.

As well as the following information:

- a. Name of corporation, partnership, Limited Liability Company, joint venture, individual or firm, submitting bid.
- b. Name of individual or representative submitting bid and position or title held on behalf of the bidder.
- c. Address of corporation, partnership, Limited Liability Company, joint venture, individual or firm, submitting bid.

d. SAP Vendor Number of corporation, partnership, Limited Liability Company, joint venture, individual or firm, submitting bid.

e. Contractor Number, if applicable, of corporation, partnership, Limited Liability Company, joint venture, individual or firm, submitting bid.

- 13.** If delivered by mail, the sealed envelope shall be placed in another sealed envelope and the outer envelope shall be addressed as follows:

**N. C. DEPARTMENT OF TRANSPORTATION
DIVISION OF HIGHWAYS, DIVISION 12**

ATTN: Mark E. Stafford

P.O. Box 47

Shelby, NC 28151-0047

- 14.** Questions should be emailed 7 calendar days prior to the bid opening to **Greg Brittain** at **gbrittain@ncdot.gov**. Contact with any other NCDOT personnel concerning this project is strictly prohibited, unless otherwise noted, and may result in bids being considered non-responsive.

PROJECT SPECIAL PROVISIONS**GENERAL****AWARD OF CONTRACT - SMALL BUSINESS ENTERPRISE PROGRAM**

Bids are being solicited for this project under the provisions of the NCDOT's Small Business Enterprise Program in accordance with *NCGS 136-28.10*.

Your firm does not have to be formally identified as a minority, woman or disabled owned business to qualify for this program, but you must have had an annual gross income of \$1.5 million or less, exclusive of materials, for the previous calendar year.

The maximum yearly contract limit is set at \$1,000,000. If the total bid amount of the contract exceeds this amount, the bid will not be considered for award. The maximum yearly contract value for all renewals cannot exceed \$1,000,000 per year.

Only contractors currently certified, as a SBE Contractor by the Contractual Services Unit of NCDOT will be eligible to bid on this contract.

For information on how to become a SBE Contractor visit the Contractual Services Website at: <https://connect.ncdot.gov/business/SmallBusiness/Pages/SBE%20Certification%20Process.aspx>

INTERESTED PARTIES LIST NOT REQUIRED:

(6-21-22)(Rev. 2-20-24)

102

SP1 G02

Revise the *Standard Specifications* as follows:

The *Interested Parties List* sign up process is not applicable to this contract.

Page 1-13, Article 102-3 PROPOSALS AND INTERESTED PARTIES LIST, lines 12-15, delete the first paragraph.

Page 1-14, Article 102-8 PREPARATION AND SUBMISSION OF BIDS, lines 43-44, delete the first sentence of the first paragraph.

BOND REQUIREMENTS – No Bonds Required

(6-1-16)(Rev. 1-16-24)

SPD 01-420B

The provisions of Articles 102-10 and 103-7 of the *Standard Specifications* are waived for this project. No bonds required.

CONTRACT TIME FOR ID/IQ:

(2-15-22)

108

SP1 G11

The date of availability for this contract is **December 30, 2024**.

The completion date for this contract is **December 29, 2025**.

Except where otherwise provided by the contract, observation periods required by the contract will not be a part of the work to be completed by the completion date and/or intermediate contract times stated in the contract. The acceptable completion of the observation periods that extend beyond the final completion date shall be a part of the work covered by the performance and payment bonds.

Work shall be accomplished in a continuous manner once the contractor begins.

Any liquidated damages for this contract will be assessed per the Mobilization and Liquidated Damages provision located elsewhere in this Contract.

WORK ORDER ASSIGNMENT (SINGLE AWARDS) FOR ID/IQ:

(2-15-22)(Rev. 4-19-22)

SPD 01-800A

Work orders will be assigned by the Engineer. The Contractor shall respond to the work order assignments with the anticipated start date, within three working days of notification unless noted otherwise. Failure to complete work in accordance with contract provisions and completion date may result in liquidated damages.

For federal ID/IQ contracts, all work orders will be assigned via the Work Order Assignment Form (Form IDIQ-1SA), and the Contractor is required to formally respond in writing for federal work orders within three working days, unless noted otherwise. The Work Order Assignment Form will also be used for any state ID/IQ contract in which the estimated work order cost meets the threshold for Performance and Payment Bonds in accordance with the Bonding Requirements for ID/IQ provision found elsewhere in this contract. For state ID/IQ contracts in which the work order assignment doesn't meet the threshold for bonds, the Department has the option to use the Work Order Assignment Form or other methods for work order assignments as agreed upon by the Engineer and Contractor.

The Contractor shall be required to prosecute the work in a continuous and uninterrupted manner from the time they begin the work until completion and final acceptance of the work order. Multiple failures of the Contractor to mobilize and begin work on the work order within the agreed upon time frame or failure to complete the work within the given time frame may result in the Contractor being excluded from future work on this contract in accordance with the *Standard Specifications*.

BONDING REQUIREMENTS FOR ID/IQ:

(2-15-22)

SPD 01-810

For purposes of this ID/IQ contract, the following definitions apply:

Project Agreement: A transportation improvement with a defined scope of work; a written agreement between NCDOT and the Federal Government defining the extent of construction work to be undertaken in accordance with the submitted plans, specifications and estimates. Execution of the agreement prompts the authorization to proceed (construction funding).

Project: An undertaking issued to a contractor through a Work Order Assignment. The construction under a Project Agreement may be accomplished by one or more work order assignments, from one or more ID/IQ contracts. Note that for ID/IQ contracts this definition supersedes the definition in the Standard Specifications.

Award: The issuance of a signed Work Order Assignment by NCDOT shall constitute the notice of award of a project.

In accordance with North Carolina General Statute 44A-26, bonds are required on contracts awarded for any one project that exceeds \$500,000. Beyond statutory requirements, NCDOT policy requires payment and performance bonds on all projects where the engineer's estimate is \$450,000 or greater, all Asphalt Surface Treatment projects, and projects containing the 12-month guarantee provision. The limit for waiving bonds for all bridge replacement and major bridge rehabilitation projects (latex overlays, etc.) is \$300,000 based on the engineer's estimate. The decision of bonding of a work order assignment below the dollar amounts listed shall be at the discretion of the Division's evaluation of the risks associated with the project.

The need for contract payment and performance bonds will be determined at the Work Order Assignment level. The Work Order Assignment will notify the Contractor of an award of a project and if required, to provide contract payment and performance bonds per Article 103-7 of the *Standard Specifications*. The Work Order Assignment replaces the Notification of Award Letter mentioned in Article 103-4(A) of the *Standard Specifications*.

MOBILIZATION AND LIQUIDATED DAMAGES FOR ID/IQ:

(2-15-22)

DIV 12-SP

The Contractor shall be informed if the work to be accomplished is routine or emergency type work. The Contractor shall mobilize to each location where work is required.

The Contractor will be provided a Work Order Assignment for each project with location(s), estimated quantities, and liquidated damages unless waived by the Engineer. Notification will be verbal followed by a faxed or emailed signed Work Order Assignment. There will be no minimum quantities for any line item associated with a particular mobilization. The Contractor shall complete the work identified on each Work Order Assignment.

The Contractor shall mobilize and complete the work within the time specified on the Work Order Assignment. Failure to complete the work by the completion date may result in the

application of liquidated damages. Liquidated damage amounts will be based on the work order estimate and the liquidated damage table below.

Work Order Value	Liquidated Damages (per calendar day)
\$0 - \$100K	\$100.00
\$100K - \$200K	\$250.00
\$200K - \$300K	\$500.00
\$300K - \$500K	\$600.00
\$500K - \$1M	\$700.00
\$1M - \$2M	\$850.00

MOBILIZATION FOR ID/IO:

(2-15-22)

Div. 12- SP

For Emergency Mobilization the Contractor shall arrive on site within **seven (7) days** of notification. Compensation will be in addition to the specific line items in the contract. *Emergency Mobilization* will be paid for at the contract unit price per each. Failure to respond within the time frame will result in nonpayment of this item.

For Routine Mobilization the Contractor shall arrive on site within **thirty (30) days** of notification. Compensation will be in addition to the specific line items in the contract. *Routine Mobilization* will be paid for at the contract unit price per each. Failure to respond within the time frame will result in nonpayment of this item.

Payment will be made under:

Pay Item	Pay Unit
Emergency Mobilization	Each
Routine Mobilization	Each

RENEWAL OF CONTRACT (CPI PRICE ADJUSTMENT) FOR ID/IO:

(2-15-22)(Rev. 9-19-23)

SPD 01-840

The Contractor shall submit a bid for one year. At the option of the Department, this contract may be extended for two (2) additional periods of one year each (maximum (3) three years total). Each year shall have a limit of **one million dollars (\$1,000,000)**.

The compensation payable to the contractor shall be fixed for the first twelve months of this contract. However, upon an application of renewal of the contract, or thirty days prior to the end of each contract period, the renewal contract may be adjusted to reflect the adjustment in the Consumer Price Index over the latest twelve month period as published by the US Bureau of Labor and Statistics at <http://www.bls.gov/cpi> to be applied to new work order assignments. The Consumer Price Index for All Urban Consumers (CPI-U), US City Average, All Items, 1982-84=100, not seasonally adjusted will be used. If the amount of the requested adjustment is more than ten percent, the Department of Transportation reserves the right to cancel this contract.

CPI adjustment values can be determined using the calculator on the NCDOT Construction website.

This price escalation method will not be applied to items of work that are separately covered under commodity price escalation clauses. No other changes in the terms, conditions, etc. of this contract will be made when an extension to the contract is implemented. The Engineer will notify the Contractor in writing **60** days prior to the contract end date if the contract may be extended. The Contractor must notify the Engineer in writing within **30** days of receiving the contract extension offer of his acceptance or rejection of this offer. Failure on the part of the Contractor to reply will be received as a rejection of contract extension. **The Department is under no obligation to renew this contract beyond the original 1 year term.**

DISPUTE RESOLUTION PROCESS FOR ID/IO:

(2-15-22)(Rev. 1-16-24)

SPD 01-850

If a question should arise on the contract or assignment of a work order, the contractor should notify the Engineer noted on the assignment documentation or the Division Engineer within 48 hours after the scheduled time of bid opening or work order assignment. The following should be included in the notification if applicable:

- (A) the contract for which bids were solicited;
- (B) the particular law, regulation, or contract specification violated;
- (C) a detailed description of the alleged violation; and
- (D) any other information deemed to be relevant.

Once the initial evaluation has been completed, the contractor may be asked to attend a meeting for further discussion and clarification.

Once a determination has been made, the contractor will be notified of the decision by the Division Engineer. If the decision does not meet the satisfaction of the contractor, they have 24 hours from the Division Engineer's notification to elevate the dispute to the Chief Engineer. The Chief Engineer will make the final decision and will not be subject to further review by NCDOT.

INTERMEDIATE CONTRACT TIME NUMBER 1 AND LIQUIDATED DAMAGES:

(2-20-07)

108

SPI G14 B

The Contractor shall complete the required work of installing, maintaining, and removing the traffic control devices for lane closures and restoring traffic to the existing traffic pattern. The Contractor shall not close or narrow a lane of traffic on **ANY NON-INTERSTATE ROUTE** during the following time restrictions unless otherwise directed by the Engineer:

NON-INTERSTATE DAY AND TIME RESTRICTIONS

MONDAY THRU FRIDAY

6:00 A.M. TO 9:00 A.M.

4:00 P.M. TO 7:00 P.M.

In addition, the Contractor shall complete the required work of installing, maintaining, and removing the traffic control devices for lane closures and restoring traffic to the existing traffic pattern. The Contractor shall not close or narrow a lane of traffic on **INTERSTATE ROUTES** during the following time restrictions or as directed by the Engineer:

INTERSTATE DAY AND TIME RESTRICTIONS

**MONDAY THRU SUNDAY
6:00 A.M. TO 9:00 P.M.**

In addition, the Contractor shall not narrow or close a lane of traffic on **ANY ROAD**, detain and /or alter the traffic flow on or during holiday weekends, special events, or any other time when traffic is unusually heavy, including the following schedules:

HOLIDAY AND HOLIDAY WEEKEND LANE CLOSURE RESTRICTIONS

1. For **unexpected occurrence** that creates unusually high traffic volumes, as directed by the Engineer.
2. For **New Year's Day**, between the hours of **7:00 AM** December 31st and **7:00 PM** January 2nd. If New Year's Day is on a Friday, Saturday, Sunday or Monday, then until **7:00 PM** the following Tuesday.
3. For **Easter**, between the hours of **7:00 AM** Thursday and **7:00 PM** Monday.
4. For **Memorial Day**, between the hours of **7:00 AM** Friday and **7:00 PM** Tuesday.
5. For **Independence Day**, between the hours of **7:00 AM** the day before Independence Day and **7:00 PM** the day after Independence Day.

If **Independence Day** is on a Friday, Saturday, Sunday or Monday, then between the hours of **7:00 AM** the Thursday before Independence Day and **7:00 PM** the Tuesday after Independence Day.
6. For **Labor Day**, between the hours of **7:00 AM** Friday and **7:00 PM** Tuesday.
7. For **Thanksgiving Day**, between the hours of **7:00 AM** Tuesday and **7:00 PM** Monday.
8. For **Christmas**, between the hours of **7:00 AM** the Friday before the week of Christmas Day and **7:00 PM** the following Tuesday after the week of Christmas Day.

Holidays and holiday weekends shall include New Year's, Easter, Memorial Day, Independence Day, Labor Day, Thanksgiving, and Christmas. The Contractor shall schedule his work so that lane closures are not required during these periods, unless otherwise directed by the Engineer.

The time of availability for this intermediate contract work shall be the time the Contractor begins to install all traffic control devices for lane closures according to the time restrictions listed herein.

The completion time for this intermediate contract work shall be the time the Contractor is required to complete the removal of all traffic control devices for lane closures according to the time restrictions stated herein and place traffic in the existing traffic pattern.

The liquidated damages are **Five Hundred Dollars (\$ 500.00)** per hour.

NO MAJOR CONTRACT ITEMS:

(2-19-02)(Rev. 8-21-07)

104

SP1 G31

None of the items included in this contract will be major items.

NO SPECIALTY ITEMS:

(7-1-95)(Rev. 1-16-24)

108-6

SP1 G34

None of the items included in this contract will be specialty items (see Article 108-6 of the *Standard Specifications*).

FUEL PRICE ADJUSTMENT PAPER BID:

(11-15-05)(Rev. 1-16-24)

109-8

SP1 G44

Revise the *Standard Specifications* as follows:

Page 1-82, Article 109-8, FUEL PRICE ADJUSTMENTS, add the following:

The base index price for DIESEL #2 FUEL is \$ **2.2926** per gallon. Where any of the following are included as pay items in the contract, they will be eligible for fuel price adjustment.

The pay items and the fuel factor used in calculating adjustments to be made will be as follows:

Description	Units	Fuel Usage Factor Diesel
Unclassified Excavation	Gal/CY	0.29
Borrow Excavation	Gal/CY	0.29
Class IV Subgrade Stabilization	Gal/Ton	0.55
Aggregate Base Course	Gal/Ton	0.55
Sub-Ballast	Gal/Ton	0.55
Erosion Control Stone	Gal/Ton	0.55
Rip Rap, Class _____	Gal/Ton	0.55
Asphalt Concrete Base Course, Type _____	Gal/Ton	0.90 or 2.90
Asphalt Concrete Intermediate Course, Type _____	Gal/Ton	0.90 or 2.90
Asphalt Concrete Surface Course, Type _____	Gal/Ton	0.90 or 2.90
Open-Graded Asphalt Friction Course	Gal/Ton	0.90 or 2.90
Permeable Asphalt Drainage Course, Type _____	Gal/Ton	0.90 or 2.90
Sand Asphalt Surface Course, Type _____	Gal/Ton	0.90 or 2.90
Ultra-thin Bonded Wearing Course	Gal/Ton	0.90 or 2.90
Aggregate for Cement Treated Base Course	Gal/Ton	0.55
Portland Cement for Cement Treated Base Course	Gal/Ton	0.55
> 11" Portland Cement Concrete Pavement	Gal/SY	0.327
Concrete Shoulders Adjacent to > 11" Pavement	Gal/SY	0.327
9" to 11" Portland Cement Concrete Pavement	Gal/SY	0.272
Concrete Shoulders Adjacent to 9" to 11" Pavement	Gal/SY	0.272
< 9" Portland Cement Concrete Pavement	Gal/SY	0.245
Concrete Shoulders Adjacent to < 9" Pavement	Gal/SY	0.245

For the asphalt items noted in the chart as eligible for fuel adjustments, the bidder may include the *Fuel Usage Factor Adjustment Form for Paper Bid* with their bid submission if they elect to use the fuel usage factor. The *Fuel Usage Factor Adjustment Form for Paper Bid* is included toward the end of this paper bid document when asphalt items noted in the chart as eligible for fuel adjustments are part of the project.

Select either 2.90 Gal/Ton fuel factor or 0.90 Gal/Ton fuel factor for each asphalt line item on the *Fuel Usage Factor Adjustment Form for Paper Bid*. The selected fuel factor for each asphalt item will remain in effect for the duration of the contract.

Failure to complete the *Fuel Usage Factor Adjustment Form for Paper Bid* will result in using 2.90 gallons per ton as the Fuel Usage Factor for Diesel for the asphalt items noted above. The contractor will not be permitted to change the Fuel Usage Factor after the bids are submitted.

SCHEDULE OF ESTIMATED COMPLETION PROGRESS:

(

All work contained in this contract will be accomplished on an as-requested basis therefore no progress schedule will be required unless otherwise directed by the Engineer.

SMALL BUSINESS ENTERPRISE (MULTI-YEAR MAINTENANCE CONTRACTS):

(4-20-21)(Rev. 2-15-22)

SP1 G74

This contract is a multi-year maintenance contract let pursuant to the Small Business Enterprise provisions of N.C. General Statute §136-28.10. No minimum quantity of services is guaranteed to be awarded bidders under this contract. In accordance with N.C. General Statute §136-28.10, an award in a contract may be for an amount less but shall not exceed \$1,000,000 per year. No payments in excess of this amount will be disbursed, in accordance with the Statute.

RESTRICTIONS ON ITS EQUIPMENT AND SERVICES:

(11-17-20)

SP01 G090

All telecommunications, video or other ITS equipment or services installed or utilized on this project must be in conformance with **UNIFORM ADMINISTRATIVE REQUIREMENTS, COST PRINCIPLES, AND AUDIT REQUIREMENTS FOR FEDERAL AWARDS 2 CFR, § 200.216 Prohibition on certain telecommunications and video surveillance services or equipment.**

USE OF UNMANNED AIRCRAFT SYSTEM (UAS):

(8-20-19)

SP1 G092

The Contractor shall adhere to all Federal, State and Local regulations and guidelines for the use of Unmanned Aircraft Systems (UAS). This includes but is not limited to US 14 CFR Part 107 *Small UAS Rule*, NC GS 15A-300.2 *Regulation of launch and recovery sites*, NC GS 63-95 *Training required for the operation of unmanned aircraft systems*, NC GS 63-96 *Permit required for commercial operation of unmanned aircraft system*, and NCDOT UAS Policy. The required operator certifications include possessing a current Federal Aviation Administration (FAA) Remote Pilot Certificate, a NC UAS Operator Permit as well as operating a UAS registered with the FAA.

Prior to beginning operations, the Contractor shall complete the NCDOT UAS – Flight Operation Approval Form and submit it to the Engineer for approval. All UAS operations shall be approved by the Engineer prior to beginning the operations.

All contractors or subcontractors operating UAS shall have UAS specific general liability insurance to cover all operations under this contract.

The use of UAS is at the Contractor's discretion. No measurement or payment will be made for the use of UAS. In the event that the Department directs the Contractor to utilize UAS, payment will be in accordance with Article 104-7 Extra Work.

EQUIPMENT IDLING GUIDELINES:

(1-19-21)

107

SP1 G096

Exercise reduced fuel consumption and reduced equipment emissions during the construction of all work associated with this contract. Employees engaged in the construction of this project should turn off vehicles when stopped for more than thirty (30) minutes and off-highway equipment should idle no longer than fifteen (15) consecutive minutes.

These guidelines for turning off vehicles and equipment when idling do not apply to:

1. Idling when queuing.
2. Idling to verify the vehicle is in safe operating condition.
3. Idling for testing, servicing, repairing or diagnostic purposes.
4. Idling necessary to accomplish work for which the vehicle was designed (such as operating a crane, mixing concrete, etc.).
5. Idling required to bring the machine system to operating temperature.
6. Emergency vehicles, utility company, construction, and maintenance vehicles where the engines must run to perform needed work.
7. Idling to ensure safe operation of the vehicle.
8. Idling when the propulsion engine is providing auxiliary power for other than heating or air conditioning. (such as hydraulic systems for pavers)
9. When specific traffic, safety, or emergency situations arise.
10. If the ambient temperature is less than 32 degrees Fahrenheit. Limited idling to provide for the safety of vehicle occupants (e.g. to run the heater).
11. If the ambient temperature is greater than 90 degrees Fahrenheit. Limited idling to provide for the safety of vehicle occupants of off-highway equipment (e.g. to run the air conditioning) no more than 30 minutes.
12. Diesel powered vehicles may idle for up to 30 minutes to minimize restart problems.

Any vehicle, truck, or equipment in which the primary source of fuel is natural gas or electricity is exempt from the idling limitations set forth in this special provision.

OUTSOURCING OUTSIDE THE USA:

(9-21-04) (Rev. 5-16-06)

SP1 G150

All work on consultant contracts, services contracts, and construction contracts shall be performed in the United States of America. No work shall be outsourced outside of the United States of America.

Outsourcing for the purpose of this provision is defined as the practice of subcontracting labor, work, services, staffing, or personnel to entities located outside of the United States.

The North Carolina Secretary of Transportation shall approve exceptions to this provision in writing.

PAYMENT (Invoices)

Payment will be made at the contract unit price. Prices and payment will be considered full compensation for all work accomplished and accepted.

All work items necessary to complete the work other than listed on the "Bid Form" will be considered incidental in nature and no further compensation will be made. Any work performed in an unsatisfactory manner shall be basis for non-payment and may result in cancellation of the contract.

Invoices shall be submitted monthly to the address listed below for work accomplished and accepted.

Invoices should be sent to:
North Carolina Department of Transportation
Attention: Jason Willis
P.O. Box 47
Shelby, NC 28151

PROJECT SPECIAL PROVISIONS**ROADWAY****PROJECT NOTES:**

1. Steel pipe installation shall be performed on an as needed basis at various sites within the Division where the existing drainage facilities are damaged or failing.
2. A preconstruction meeting shall be held at each site prior to beginning work in accordance with Section 330 of the Standard Specifications.
3. All OSHA regulations for trenching and shoring shall be adhered to on this project. For more information go to the following website:
<https://www.osha.gov/Publications/osha2226.pdf>
4. Any necessary traffic control will be provided by the Department.
5. Any necessary erosion control will be provided by the Department.

FLOWABLE FILL:

(9-17-02)(Rev. 1-16-24)

300, 340, 1000, 1530, 1540, 1550

SP3 R30

Description

This work consists of all work necessary to place flowable fill in accordance with these provisions, the plans, and as directed.

Materials

Refer to Division 10 of the *Standard Specifications*.

Item

Flowable Fill

Section

1000-7

Construction Methods

Discharge flowable fill material directly from the truck into the space to be filled, or by other approved methods. The mix may be placed full depth or in lifts as site conditions dictate. The Contractor shall provide a method to plug the ends of the existing pipe in order to contain the flowable fill.

Measurement and Payment

At locations where flowable fill is called for on the plans and a pay item for flowable fill is included in the contract, *Flowable Fill* will be measured in cubic yards and paid as the actual number of cubic yards that have been satisfactorily placed and accepted. Such price and payment will be full compensation for all work covered by this provision including, but not limited to, the mix design, furnishing, hauling, placing and containing the flowable fill.

Payment will be made under:

Pay Item

Flowable Fill

Pay Unit

Cubic Yard

COOPERATION WITH STATE FORCES AND OTHER CONTRACTORS

The Contractor must cooperate with State forces and other Contractors working within the limits of this project as directed by the Engineer.

PRESERVATION OF PROPERTY

The Contractor shall exercise care to avoid damage to all public and private property and facilities. Any damage to properties, such as, but not limited to, mailboxes, fences, gates, vehicles, driveways, etc. shall immediately be restored to the previously existing condition by the contractor. No payment will be made to the Contractor for such restorative work.

DRIVEWAY ACCESS

The Contractor shall maintain access to driveways for all businesses, residents and property owners throughout the life of the project.

The Contractor shall not perform work for private citizens or agencies in conjunction with this project or within the project limits of this contract. Any driveway to be paved by the Contractor, which ties into a NCDOT system road being paved by the Contractor, must be paved either prior to the road paving project or after its completion.

TRAFFIC SIGNS & MAILBOXES

Permanent traffic signs and mailboxes that interfere with the road construction operations are to be removed during the course of a day's work and be re-installed at the conclusion of each workday. The contractor shall mark the proper location of the signs and mailboxes by placing an offset stake behind the ditch line to ensure proper replacement.

BURNING RESTRICTIONS:

(7-1-95)

200, 210, 215

SP2 R05

Open burning is not permitted on any portion of the right-of-way limits established for this project. Do not burn the clearing, grubbing or demolition debris designated for disposal and generated from the project at locations within the project limits, off the project limits or at any waste or borrow sites in this county. Dispose of the clearing, grubbing and demolition debris by means other than burning, according to state or local rules and regulations.

UTILITY CONFLICTS

Contractor shall be responsible for contacting any affected utility owners and determining the precise locations of all utilities prior to beginning construction.

Special care shall be used in working around or near existing utilities, protecting them when necessary to provide uninterrupted service. In the event that any utility service is interrupted, the Contractor shall notify NCDOT personnel and the utility owner immediately, and shall cooperate with the owner, or his representative, in the restoration of service in the shortest time possible. Any damage caused to existing utilities by the Contractor is the responsibility of the Contractor to repair at no cost to NCDOT.

Existing fire hydrants shall be kept accessible to fire departments at all times.

The Contractor shall adhere to all applicable regulations and follow accepted safety procedures when working in the vicinity of utilities in order to ensure the safety of construction personnel and the public.

STANDARD SPECIAL PROVISION
AVAILABILITY OF FUNDS – TERMINATION OF CONTRACTS

(5-20-08)(Rev. 1-16-24)

Z-2

General Statute 143C-6-11. (h) Highway Appropriation is hereby incorporated verbatim in this contract as follows:

(h) Amounts Encumbered. – Transportation project appropriations may be encumbered in the amount of allotments made to the Department of Transportation by the Director for the estimated payments for transportation project contract work to be performed in the appropriation fiscal year. The allotments shall be multiyear allotments and shall be based on estimated revenues and shall be subject to the maximum contract authority contained in *General Statute 143C-6-11(c)*. Payment for transportation project work performed pursuant to contract in any fiscal year other than the current fiscal year is subject to appropriations by the General Assembly. Transportation project contracts shall contain a schedule of estimated completion progress, and any acceleration of this progress shall be subject to the approval of the Department of Transportation provided funds are available. The State reserves the right to terminate or suspend any transportation project contract, and any transportation project contract shall be so terminated or suspended if funds will not be available for payment of the work to be performed during that fiscal year pursuant to the contract. In the event of termination of any contract, the contractor shall be given a written notice of termination at least 60 days before completion of scheduled work for which funds are available. In the event of termination, the contractor shall be paid for the work already performed in accordance with the contract specifications.

Payment will be made on any contract terminated pursuant to the special provision in accordance with Subarticle 108-13(D) of the *Standard Specifications*.

STANDARD SPECIAL PROVISION
ERRATA

(1-16-24)

Z-4

Revise the *2024 Standard Specifications* as follows:

Division 3

Page 3-5, Article 305-2 MATERIALS, after line 16, replace " 1032-3(A)(7)" with "1032-3" and add the item "Galvanized Corrugated Steel Pipe" with Section "1032-3".

Page 3-6, Article 310-2 MATERIALS, after line 9, add the item "Galvanized Corrugated Steel Pipe" with Section "1032-3".

Division 9

Page 9-17, Article 904-4 MEASUREMENT AND PAYMENT, prior to line 1, replace " Sign Erection, Relocate Type (Ground Mounted)" with "Sign Erection, Relocate Type ___ (Ground Mounted)".

Division 10

Page 10-51, Article 1024-4 WATER, prior to line 1, delete the "unpopulated blank row" in Table 1024-2 between "Time of set, deviation from control" and "Chloride Ion Content, Max.".

Page 10-170, Subarticle 1081-1(C) Requirements, line 4, replace "maximum" with "minimum".

Division 11

Page 11-15, Article 1160-4 MEASUREMENT AND PAYMENT, line 24, replace "Where barrier units are moved more than one" with "Where barrier units are moved more than once".

Division 15

Page 15-10, Article 1515-4 MEASUREMENT AND PAYMENT, lines 11, replace " All piping" with "All labor, the manhole, other materials, excavation, backfilling, piping".

Division 16

Page 16-14, Article 1633-5 MEASUREMENT AND PAYMENT, line 20-24 and prior to line 25, delete and replace with the following " *Flocculant* will be measured and paid in accordance with Article 1642-5 applied to the temporary rock silt checks."

Page 16-3, Article 1609-2 MATERIALS, after line 26, replace "Type 4" with "Type 4a".

Page 16-25, Article 1644-2 MATERIALS, after line 22, replace "Type 4" with "Type 4a".

STANDARD SPECIAL PROVISION**PLANT AND PEST QUARANTINES****(Imported Fire Ant, Gypsy Moth, Witchweed, Emerald Ash Borer, Guava Root Knot Nematode, And Other Noxious Weeds)**

(3-18-03) (Rev. 5-21-19)

Z-04a

Within Quarantined Area

This project may be within a county regulated for plant and/or pests. If the project or any part of the Contractor's operations is located within a quarantined area, thoroughly clean all equipment prior to moving out of the quarantined area. Comply with federal/state regulations by obtaining a certificate or limited permit for any regulated article moving from the quarantined area.

Originating in a Quarantined County

Obtain a certificate or limited permit issued by the N.C. Department of Agriculture/United States Department of Agriculture. Have the certificate or limited permit accompany the article when it arrives at the project site.

Contact

Contact the N.C. Department of Agriculture/United States Department of Agriculture at 1-800-206-9333, 919-707-3730, or <https://www.ncagr.gov/plantindustry/Plant/quaran/table2.htm> to determine those specific project sites located in the quarantined area or for any regulated article used on this project originating in a quarantined county.

Regulated Articles Include

1. Soil, sand, gravel, compost, peat, humus, muck, and decomposed manure, separately or with other articles. This includes movement of articles listed above that may be associated with cut/waste, ditch pulling, and shoulder cutting.
2. Plants with roots including grass sod.
3. Plant crowns and roots.
4. Bulbs, corms, rhizomes, and tubers of ornamental plants.
5. Hay, straw, fodder, and plant litter of any kind.
6. Clearing and grubbing debris.
7. Used agricultural cultivating and harvesting equipment.
8. Used earth-moving equipment.
9. Any other products, articles, or means of conveyance, of any character, if determined by an inspector to present a hazard of spreading imported fire ant, gypsy moth, witchweed, emerald ash borer, guava root knot nematode, or other noxious weeds.

STANDARD SPECIAL PROVISION**MINIMUM WAGES**

(7-21-09)

Z-5

FEDERAL: The Fair Labor Standards Act provides that with certain exceptions every employer shall pay wages at the rate of not less than SEVEN DOLLARS AND TWENTY FIVE CENTS (\$7.25) per hour.

STATE: The North Carolina Minimum Wage Act provides that every employer shall pay to each of his employees, wages at a rate of not less than SEVEN DOLLARS AND TWENTY FIVE CENTS (\$7.25) per hour.

The minimum wage paid to all skilled labor employed on this contract shall be SEVEN DOLLARS AND TWENTY FIVE CENTS (\$7.25) per hour.

The minimum wage paid to all intermediate labor employed on this contract shall be SEVEN DOLLARS AND TWENTY FIVE CENTS (\$7.25) per hour.

The minimum wage paid to all unskilled labor on this contract shall be SEVEN DOLLARS AND TWENTY FIVE CENTS (\$7.25) per hour.

This determination of the intent of the application of this act to the contract on this project is the responsibility of the Contractor.

The Contractor shall have no claim against the Department of Transportation for any changes in the minimum wage laws, Federal or State. It is the responsibility of the Contractor to keep fully informed of all Federal and State Laws affecting his contract.

STANDARD SPECIAL PROVISION**TITLE VI AND NONDISCRIMINATION:**

(6-28-77)(Rev 1/16/2024)

Z-6

The North Carolina Department of Transportation is committed to carrying out the U.S. Department of Transportation's policy of ensuring nondiscrimination in the award and administration of contracts.

The provisions of this section related to United States Department of Transportation (US DOT) Order 1050.2A, Title 49 Code of Federal Regulations (CFR) part 21, 23 United States Code (U.S.C.) 140 and 23 CFR part 200 (or 49 CFR 303, 49 U.S.C. 5332 or 49 U.S.C. 47123) are applicable to all North Carolina Department of Transportation (NCDOT) contracts and to all related subcontracts, material supply, engineering, architectural and other service contracts, regardless of dollar amount. Any Federal provision that is specifically required not specifically set forth is hereby incorporated by reference.

(1) Title VI Assurances (USDOT Order 1050.2A, Appendix A)

During the performance of this contract, the contractor, for itself, its assignees, and successors in interest (hereinafter referred to as the "contractor") agrees as follows:

(a) Compliance with Regulations

The contractor (hereinafter includes consultants) shall comply with the Acts and the Regulations relative to Nondiscrimination in Federally-assisted programs of the U.S. Department of Transportation, Federal Highway Administration (FHWA), as they may be amended from time to time, which are herein incorporated by reference and made a part of this contract.

(b) Nondiscrimination

The contractor, with regard to the work performed by it during the contract, shall not discriminate on the grounds of race, color, or national origin in the selection and retention of subcontractors, including procurements of materials and leases of equipment. The contractor shall not participate directly or indirectly in the discrimination prohibited by the Acts and the Regulations, including employment practices when the contract covers any activity, project, or program set forth in Appendix B of 49 CFR Part 21.

(c) Solicitations for Subcontractors, Including Procurements of Materials and Equipment

In all solicitations, either by competitive bidding, or negotiation made by the contractor for work to be performed under a subcontract, including procurements of materials, or leases of equipment, each potential subcontractor or supplier shall be notified by the contractor of the contractor's obligations under this contract and the Acts and the Regulations relative to Nondiscrimination on the grounds of race, color, or national origin.

(d) Information and Reports

The contractor shall provide all information and reports required by the Acts, the Regulations, and directives issued pursuant thereto and shall permit access to its

books, records, accounts, other sources of information, and its facilities as may be determined by the Recipient or the FHWA to be pertinent to ascertain compliance with such Acts, Regulations, and instructions. Where any information required of a contractor is in the exclusive possession of another who fails or refuses to furnish the information, the contractor shall so certify to the Recipient or the FHWA, as appropriate, and shall set forth what efforts it has made to obtain the information.

(e) Sanctions for Noncompliance:

In the event of a contractor's noncompliance with the Non-discrimination provisions of this contract, the Recipient will impose such contract sanctions as it and/or the FHWA may determine to be appropriate, including, but not limited to:

- (i) Withholding payments to the contractor under the contract until the contractor complies; and/or
- (ii) Cancelling, terminating, or suspending a contract, in whole or in part.

(f) Incorporation of Provisions

The contractor shall include the provisions of paragraphs (a) through (f) in every subcontract, including procurements of materials and leases of equipment, unless exempt by the Acts, the Regulations and directives issued pursuant thereto. The contractor shall take action with respect to any subcontract or procurement as the Recipient or the FHWA may direct as a means of enforcing such provisions including sanctions for noncompliance. Provided, that if the contractor becomes involved in, or is threatened with litigation by a subcontractor, or supplier because of such direction, the contractor may request the Recipient to enter into any litigation to protect the interests of the Recipient. In addition, the contractor may request the United States to enter into the litigation to protect the interests of the United States.

(2) Title VI Nondiscrimination Program (23 CFR 200.5(p))

The North Carolina Department of Transportation (NCDOT) has assured the USDOT that, as a condition to receiving federal financial assistance, NCDOT will comply with Title VI of the Civil Rights Act of 1964 and all requirements imposed by Title 49 CFR part 21 and related nondiscrimination authorities to ensure that no person shall, on the ground of race, color, national origin, limited English proficiency, sex, age, or disability (including religion/creed or income-level, where applicable), be excluded from participation in, be denied the benefits of, or be subjected to discrimination under any programs, activities, or services conducted or funded by NCDOT. Contractors and other organizations under contract or agreement with NCDOT must also comply with Title VI and related authorities, therefore:

- (a) During the performance of this contract or agreement, contractors (e.g., subcontractors, consultants, vendors, prime contractors) are responsible for complying with NCDOT's Title VI Program. Contractors are not required to prepare or submit Title VI Programs. To comply with this section, the prime contractor shall:
 1. Post NCDOT's Notice of Nondiscrimination and the Contractor's own Equal Employment Opportunity (EEO) Policy in conspicuous locations accessible to all employees, applicants and subcontractors on the jobsite.

2. Physically incorporate the required Title VI clauses into all subcontracts on federally-assisted and state-funded NCDOT projects, and ensure inclusion by subcontractors into all lower-tier subcontracts.
 3. Required Solicitation Language. The Contractor shall include the following notification in all solicitations for bids and requests for work or material, regardless of funding source:

“The North Carolina Department of Transportation, in accordance with the provisions of Title VI of the Civil Rights Act of 1964 (78 Stat. 252, 42 U.S.C. §§ 2000d to 2000d-4) and the Regulations, hereby notifies all bidders that it will affirmatively ensure that any contract entered into pursuant to this advertisement, disadvantaged business enterprises will be afforded full and fair opportunity to submit bids in response to this invitation and will not be discriminated against on the grounds of race, color, or national origin in consideration for an award. In accordance with other related nondiscrimination authorities, bidders and contractors will also not be discriminated against on the grounds of sex, age, disability, low-income level, creed/religion, or limited English proficiency in consideration for an award.”
 4. Physically incorporate the FHWA-1273, in its entirety, into all subcontracts and subsequent lower tier subcontracts on Federal-aid highway construction contracts only.
 5. Provide language assistance services (i.e., written translation and oral interpretation), free of charge, to LEP employees and applicants. Contact NCDOT OCR for further assistance, if needed.
 6. For assistance with these Title VI requirements, contact the NCDOT Title VI Nondiscrimination Program at 1-800-522-0453.
- (b) Subrecipients (e.g. cities, counties, LGAs, planning organizations) may be required to prepare and submit a Title VI Plan to NCDOT, including Title VI Assurances and/or agreements. Subrecipients must also ensure compliance by their contractors and subrecipients with Title VI. (23 CFR 200.9(b)(7))
- (c) If reviewed or investigated by NCDOT, the contractor or subrecipient agrees to take affirmative action to correct any deficiencies found within a reasonable time period, not to exceed 90 calendar days, unless additional time is granted by NCDOT. (23 CFR 200.9(b)(15))
- (d) The Contractor is responsible for notifying subcontractors of NCDOT’s External Discrimination Complaints Process.
1. Applicability

Title VI and related laws protect participants and beneficiaries (e.g., members of the public and contractors) from discrimination by NCDOT employees, subrecipients and contractors, regardless of funding source.

2. Eligibility

Any person—or class of persons—who believes he/she has been subjected to discrimination based on race, color, national origin, Limited English Proficiency (LEP), sex, age, or disability (and religion in the context of employment, aviation, or transit) may file a written complaint. The law also prohibits intimidation or retaliation of any sort.

3. Time Limits and Filing Options

Complaints may be filed by the affected individual(s) or a representative and must be filed no later than 180 calendar days after the following:

- (i) The date of the alleged act of discrimination; or
- (ii) The date when the person(s) became aware of the alleged discrimination; or
- (iii) Where there has been a continuing course of conduct, the date on which that conduct was discontinued or the latest instance of the conduct.

Title VI and related discrimination complaints may be submitted to the following entities:

- North Carolina Department of Transportation, Office of Civil Rights, Title VI Program, 1511 Mail Service Center, Raleigh, NC 27699-1511; toll free 1-800-522-0453
- Federal Highway Administration, North Carolina Division Office, 310 New Bern Avenue, Suite 410, Raleigh, NC 27601, 919-747-7010
- US Department of Transportation, Departmental Office of Civil Rights, External Civil Rights Programs Division, 1200 New Jersey Avenue, SE, Washington, DC 20590; 202-366-4070

4. Format for Complaints

Complaints must be in writing and signed by the complainant(s) or a representative, and include the complainant's name, address, and telephone number. Complaints received by fax or e-mail will be acknowledged and processed. Allegations received by telephone will be reduced to writing and provided to the complainant for confirmation or revision before processing. Complaints will be accepted in other languages, including Braille.

5. Discrimination Complaint Form

Contact NCDOT Civil Rights to receive a full copy of the Discrimination Complaint Form and procedures.

6. Complaint Basis

Allegations must be based on issues involving race, color, national origin (LEP), sex, age, disability, or religion (in the context of employment, aviation or transit). "Basis" refers to the complainant's membership in a protected group category.

**TABLE 103-1
COMPLAINT BASIS**

Protected Categories	Definition	Examples	Applicable Nondiscrimination Authorities
Race and Ethnicity	An individual belonging to one of the accepted racial groups; or the perception, based usually on physical characteristics that a person is a member of a racial group	Black/African American, Hispanic/Latino, Asian, American Indian/Alaska Native, Native Hawaiian/Pacific Islander, White	Title VI of the Civil Rights Act of 1964; 49 CFR Part 21; 23 CFR 200; 49 U.S.C. 5332(b); 49 U.S.C. 47123. (<i>Executive Order 13166</i>)
Color	Color of skin, including shade of skin within a racial group	Black, White, brown, yellow, etc.	
National Origin (<i>Limited English Proficiency</i>)	Place of birth. Citizenship is not a factor. (<i>Discrimination based on language or a person's accent is also covered</i>)	Mexican, Cuban, Japanese, Vietnamese, Chinese	
Sex	Gender. The sex of an individual. <i>Note: Sex under this program does not include sexual orientation.</i>	Women and Men	1973 Federal-Aid Highway Act; 49 U.S.C. 5332(b); 49 U.S.C. 47123.
Age	Persons of any age	21-year-old person	Age Discrimination Act of 1975 49 U.S.C. 5332(b); 49 U.S.C. 47123.
Disability	Physical or mental impairment, permanent or temporary, or perceived.	Blind, alcoholic, para-amputee, epileptic, diabetic, arthritic	Section 504 of the Rehabilitation Act of 1973; Americans with Disabilities Act of 1990
Religion (in the context of employment) (<i>Religion/ Creed in all aspects of any aviation or transit-related construction</i>)	An individual belonging to a religious group; or the perception, based on distinguishable characteristics that a person is a member of a religious group. In practice, actions taken as a result of the moral and ethical beliefs as to what is right and wrong, which are sincerely held with the strength of traditional religious views. <i>Note: Does not have to be associated with a recognized religious group or church; if an individual sincerely holds to the belief, it is a protected religious practice.</i>	Muslim, Christian, Sikh, Hindu, etc.	Title VII of the Civil Rights Act of 1964; 23 CFR 230; FHWA-1273 Required Contract Provisions. (<i>49 U.S.C. 5332(b); 49 U.S.C. 47123</i>)

(3) Pertinent Nondiscrimination Authorities

During the performance of this contract, the contractor, for itself, its assignees, and successors in interest agrees to comply with the following non-discrimination statutes and authorities, including, but not limited to:

- (a) Title VI of the Civil Rights Act of 1964 (42 U.S.C. § 2000d et seq., 78 stat. 252), (prohibits discrimination on the basis of race, color, national origin); and 49 CFR Part 21.

- (b) The Uniform Relocation Assistance and Real Property Acquisition Policies Act of 1970, (42 U.S.C. § 4601), (prohibits unfair treatment of persons displaced or whose property has been acquired because of Federal or Federal-aid programs and projects);
- (c) Federal-Aid Highway Act of 1973, (23 U.S.C. § 324 et seq.), (prohibits discrimination on the basis of sex);
- (d) Section 504 of the Rehabilitation Act of 1973, (29 U.S.C. § 794 et seq.), as amended, (prohibits discrimination on the basis of disability) and 49 CFR Part 27;
- (e) The Age Discrimination Act of 1975, as amended, (42 U.S.C. § 6101 et seq.), (prohibits discrimination on the basis of age);
- (f) Airport and Airway Improvement Act of 1982, (49 USC § 471, Section 47123), as amended, (prohibits discrimination based on race, creed, color, national origin, or sex);
- (g) The Civil Rights Restoration Act of 1987, (PL 100-209), (Broadened the scope, coverage and applicability of Title VI of the Civil Rights Act of 1964, The Age Discrimination Act of 1975 and Section 504 of the Rehabilitation Act of 1973, by expanding the definition of the terms "programs or activities" to include all of the programs or activities of the Federal-aid recipients, sub-recipients and contractors, whether such programs or activities are Federally funded or not);
- (h) Titles II and III of the Americans with Disabilities Act, which prohibit discrimination on the basis of disability in the operation of public entities, public and private transportation systems, places of public accommodation, and certain testing entities (42 U.S.C. §§ 12131-12189) as implemented by Department of Transportation regulations at 49 C.F.R. parts 37 and 38;
- (i) The Federal Aviation Administration's Nondiscrimination statute (49 U.S.C. § 47123) (prohibits discrimination on the basis of race, color, national origin, and sex);
- (j) Executive Order 12898, Federal Actions to Address Environmental Justice in Minority Populations and Low-Income Populations, which ensures Nondiscrimination against minority populations by discouraging programs, policies, and activities with disproportionately high and adverse human health or environmental effects on minority and low-income populations;
- (k) Executive Order 13166, Improving Access to Services for Persons with Limited English Proficiency, and resulting agency guidance, national origin discrimination includes discrimination because of Limited English proficiency (LEP). To ensure compliance with Title VI, you must take reasonable steps to ensure that LEP persons have meaningful access to your programs (70 Fed. Reg. at 74087 to 74100);
- (l) Title IX of the Education Amendments of 1972, as amended, which prohibits you from discriminating because of sex in education programs or activities (20 U.S.C. 1681 et seq).
- (m) Title VII of the Civil Rights Act of 1964 (42 U.S.C. § 2000e et seq., Pub. L. 88-352), (prohibits employment discrimination on the basis of race, color, religion, sex, or national origin).

(4) Additional Title VI Assurances

***The following Title VI Assurances (Appendices B, C and D) shall apply, as applicable*

- (a) Clauses for Deeds Transferring United States Property (1050.2A, Appendix B)

The following clauses will be included in deeds effecting or recording the transfer of real property, structures, or improvements thereon, or granting interest therein from the United States pursuant to the provisions of Assurance 4.

NOW, THEREFORE, the U.S. Department of Transportation as authorized by law and upon the condition that the North Carolina Department of Transportation (NCDOT) will accept title to the lands and maintain the project constructed thereon in accordance with the North Carolina General Assembly, the Regulations for the Administration of the Federal-Aid Highway Program, and the policies and procedures prescribed by the Federal Highway Administration of the U.S. Department of Transportation in accordance and in compliance with all requirements imposed by Title 49, Code of Federal Regulations, U.S. Department of Transportation, Subtitle A, Office of the Secretary, Part 21, Nondiscrimination in Federally-assisted programs of the U.S. Department of Transportation pertaining to and effectuating the provisions of Title VI of the Civil Rights Act of 1964 (78 Stat. 252; 42 U.S.C. § 2000d to 2000d-4), does hereby remise, release, quitclaim and convey unto the NCDOT all the right, title and interest of the U.S. Department of Transportation in and to said lands described in Exhibit A attached hereto and made a part hereof.

(HABENDUM CLAUSE)

TO HAVE AND TO HOLD said lands and interests therein unto the North Carolina Department of Transportation (NCDOT) and its successors forever, subject, however, to the covenants, conditions, restrictions and reservations herein contained as follows, which will remain in effect for the period during which the real property or structures are used for a purpose for which Federal financial assistance is extended or for another purpose involving the provision of similar services or benefits and will be binding on the NCDOT, its successors and assigns.

The NCDOT, in consideration of the conveyance of said lands and interests in lands, does hereby covenant and agree as a covenant running with the land for itself, its successors and assigns, that (1) no person will on the grounds of race, color, or national origin, be excluded from participation in, be denied the benefits of, or be otherwise subjected to discrimination with regard to any facility located wholly or in part on, over, or under such lands hereby conveyed [,] [and]* (2) that the NCDOT will use the lands and interests in lands and interests in lands so conveyed, in compliance with all requirements imposed by or pursuant to Title 49, Code of Federal Regulations, U.S. Department of Transportation, Subtitle A, Office of the Secretary, Part 21, Non-discrimination in Federally-assisted programs of the U.S. Department of Transportation, Effectuation of Title VI of the Civil Rights Act of 1964, and as said Regulations and Acts may be amended [, and (3) that in the event of breach of any of the above-mentioned nondiscrimination conditions, the Department will have a right to enter or re-enter said lands and facilities on said land, and that above described land and facilities will thereon revert to and vest in and become the absolute property of the U.S. Department of Transportation and its assigns as such interest existed prior to this instruction].*

(*Reverter clause and related language to be used only when it is determined that such a clause is necessary in order to make clear the purpose of Title VI.)

(b) Clauses for Transfer of Real Property Acquired or Improved Under the Activity, Facility, or Program (1050.2A, Appendix C)

The following clauses will be included in deeds, licenses, leases, permits, or similar instruments entered into by the North Carolina Department of Transportation (NCDOT) pursuant to the provisions of Assurance 7(a):

1. The (grantee, lessee, permittee, etc. as appropriate) for himself/herself, his/her heirs, personal representatives, successors in interest, and assigns, as a part of the consideration hereof, does hereby covenant and agree [in the case of deeds and leases add "as a covenant running with the land"] that:
 - (i.) In the event facilities are constructed, maintained, or otherwise operated on the property described in this (deed, license, lease, permit, etc.) for a purpose for which a U.S. Department of Transportation activity, facility, or program is extended or for another purpose involving the provision of similar services or benefits, the (grantee, licensee, lessee, permittee, etc.) will maintain and operate such facilities and services in compliance with all requirements imposed by the Acts and Regulations (as may be amended) such that no person on the grounds of race, color, or national origin, will be excluded from participation in, denied the benefits of, or be otherwise subjected to discrimination in the use of said facilities.
2. With respect to licenses, leases, permits, etc., in the event of breach of any of the above Nondiscrimination covenants, the NCDOT will have the right to terminate the (lease, license, permit, etc.) and to enter, re-enter, and repossess said lands and facilities thereon, and hold the same as if the (lease, license, permit, etc.) had never been made or issued. *
3. With respect to a deed, in the event of breach of any of the above Nondiscrimination covenants, the NCDOT will have the right to enter or re-enter the lands and facilities thereon, and the above described lands and facilities will there upon revert to and vest in and become the absolute property of the NCDOT and its assigns. *

(*Reverter clause and related language to be used only when it is determined that such a clause is necessary to make clear the purpose of Title VI.)

(c) Clauses for Construction/Use/Access to Real Property Acquired Under the Activity, Facility or Program (1050.2A, Appendix D)

The following clauses will be included in deeds, licenses, permits, or similar instruments/ agreements entered into by the North Carolina Department of Transportation (NCDOT) pursuant to the provisions of Assurance 7(b):

1. The (grantee, licensee, permittee, etc., as appropriate) for himself/herself, his/her heirs, personal representatives, successors in interest, and assigns, as a part of the consideration hereof, does hereby covenant and agree (in the case of deeds and leases add, "as a covenant running with the land") that (1) no person on the ground of race, color, or national origin, will be excluded from participation in, denied the benefits of, or be otherwise subjected to discrimination in the use of said facilities, (2) that in the construction of any improvements on, over, or under such land, and the furnishing of services thereon, no person on the ground of race, color, or national origin, will be excluded from participation in, denied the benefits of, or otherwise be subjected to discrimination, (3) that the (grantee, licensee, lessee, permittee, etc.) will use the premises in compliance with all other requirements imposed by or pursuant to the Acts and Regulations, as amended, set forth in this Assurance.
2. With respect to (licenses, leases, permits, etc.), in the event of breach of any of the above Non-discrimination covenants, the NCDOT will have the right to terminate the (license, permit, etc., as appropriate) and to enter or re-enter and repossess said land and the facilities thereon, and hold the same as if said (license, permit, etc., as appropriate) had never been made or issued. *
3. With respect to deeds, in the event of breach of any of the above Nondiscrimination covenants, the NCDOT will there upon revert to and vest in and become the absolute property of the NCDOT and its assigns. *

(*Reverter clause and related language to be used only when it is determined that such a clause is necessary to make clear the purpose of Title VI.)

STANDARD SPECIAL PROVISION**ON-THE-JOB TRAINING**

(10-16-07) (Rev. 4-21-15)

Z-10

Description

The North Carolina Department of Transportation will administer a custom version of the Federal On-the-Job Training (OJT) Program, commonly referred to as the Alternate OJT Program. All contractors (existing and newcomers) will be automatically placed in the Alternate Program. Standard OJT requirements typically associated with individual projects will no longer be applied at the project level. Instead, these requirements will be applicable on an annual basis for each contractor administered by the OJT Program Manager.

On the Job Training shall meet the requirements of 23 CFR 230.107 (b), 23 USC – Section 140, this provision and the On-the-Job Training Program Manual.

The Alternate OJT Program will allow a contractor to train employees on Federal, State and privately funded projects located in North Carolina. However, priority shall be given to training employees on NCDOT Federal-Aid funded projects.

Minorities and Women

Developing, training and upgrading of minorities and women toward journeyman level status is a primary objective of this special training provision. Accordingly, the Contractor shall make every effort to enroll minority and women as trainees to the extent that such persons are available within a reasonable area of recruitment. This training commitment is not intended, and shall not be used, to discriminate against any applicant for training, whether a member of a minority group or not.

Assigning Training Goals

The Department, through the OJT Program Manager, will assign training goals for a calendar year based on the contractors' past three years' activity and the contractors' anticipated upcoming year's activity with the Department. At the beginning of each year, all contractors eligible will be contacted by the Department to determine the number of trainees that will be assigned for the upcoming calendar year. At that time the Contractor shall enter into an agreement with the Department to provide a self-imposed on-the-job training program for the calendar year. This agreement will include a specific number of annual training goals agreed to by both parties. The number of training assignments may range from 1 to 15 per contractor per calendar year. The Contractor shall sign an agreement to fulfill their annual goal for the year.\

Training Classifications

The Contractor shall provide on-the-job training aimed at developing full journeyman level workers in the construction craft/operator positions. Preference shall be given to providing training in the following skilled work classifications:

Equipment Operators	Office Engineers
Truck Drivers	Estimators
Carpenters	Iron / Reinforcing Steel Workers
Concrete Finishers	Mechanics
Pipe Layers	Welders

The Department has established common training classifications and their respective training requirements that may be used by the contractors. However, the classifications established are not all-inclusive. Where the training is oriented toward construction applications, training will be allowed in lower-level management positions such as office engineers and estimators. Contractors shall submit new classifications for specific job functions that their employees are performing. The Department will review and recommend for acceptance to FHWA the new classifications proposed by contractors, if applicable. New classifications shall meet the following requirements:

Proposed training classifications are reasonable and realistic based on the job skill classification needs, and

The number of training hours specified in the training classification is consistent with common practices and provides enough time for the trainee to obtain journeyman level status.

The Contractor may allow trainees to be trained by a subcontractor provided that the Contractor retains primary responsibility for meeting the training and this provision is made applicable to the subcontract. However, only the Contractor will receive credit towards the annual goal for the trainee.

Where feasible, 25 percent of apprentices or trainees in each occupation shall be in their first year of apprenticeship or training. The number of trainees shall be distributed among the work classifications on the basis of the contractor's needs and the availability of journeymen in the various classifications within a reasonable area of recruitment.

No employee shall be employed as a trainee in any classification in which they have successfully completed a training course leading to journeyman level status or in which they have been employed as a journeyman.

Records and Reports

The Contractor shall maintain enrollment, monthly and completion reports documenting company compliance under these contract documents. These documents and any other information as requested shall be submitted to the OJT Program Manager.

Upon completion and graduation of the program, the Contractor shall provide each trainee with a certification Certificate showing the type and length of training satisfactorily completed.

Trainee Interviews

All trainees enrolled in the program will receive an initial and Trainee/Post graduate interview conducted by the OJT program staff.

Trainee Wages

Contractors shall compensate trainees on a graduating pay scale based upon a percentage of the prevailing minimum journeyman wages (Davis-Bacon Act). Minimum pay shall be as follows:

60 percent	of the journeyman wage for the first half of the training period
75 percent	of the journeyman wage for the third quarter of the training period
90 percent	of the journeyman wage for the last quarter of the training period

In no instance shall a trainee be paid less than the local minimum wage. The Contractor shall adhere to the minimum hourly wage rate that will satisfy both the NC Department of Labor (NCDOL) and the Department.

Achieving or Failing to Meet Training Goals

The Contractor will be credited for each trainee employed by him on the contract work who is currently enrolled or becomes enrolled in an approved program and who receives training for at least 50 percent of the specific program requirement. Trainees will be allowed to be transferred between projects if required by the Contractor's scheduled workload to meet training goals.

If a contractor fails to attain their training assignments for the calendar year, they may be taken off the NCDOT's Bidders List.

Measurement and Payment

No compensation will be made for providing required training in accordance with these contract documents.

Fuel Usage Factor Adjustment Form for Paper Bid

Contract Number	
County	
Contractor Name	
HiCAMS Vendor Number	

Select a Fuel Usage Factor for each of the Asphalt Material Descriptions to be used on the project. Within the Selected Fuel Usage Factor column, choose either 2.90 or 0.90 Gallons per Ton for the corresponding asphalt material description.

The Selected Fuel Usage Factor chosen will be used for the entire contract duration.

Description	Unit	Selected Fuel Usage Factor	
		0.90	2.90
Asphalt Concrete Base Course, Type B25.0C	Gal/Ton		
Asphalt Concrete Intermediate Course, Type I19.0C	Gal/Ton		
Asphalt Concrete Surface Course, Type SA-1	Gal/Ton		
Asphalt Concrete Surface Course, Type SA-1 (Leveling Course)	Gal/Ton		
Asphalt Concrete Surface Course, Type S4.75	Gal/Ton		
Asphalt Concrete Surface Course, Type S4.75 (Leveling Course)	Gal/Ton		
Asphalt Concrete Surface Course, Type S9.5B	Gal/Ton		
Asphalt Concrete Surface Course, Type S9.5B (Leveling Course)	Gal/Ton		
Asphalt Concrete Surface Course, Type S9.5C	Gal/Ton		
Asphalt Concrete Surface Course, Type S9.5C (Leveling Course)	Gal/Ton		
Asphalt Concrete Surface Course, Type S9.5D	Gal/Ton		
Asphalt Concrete Surface Course, Type S9.5D (Leveling Course)	Gal/Ton		
Open-Graded Asphalt Friction Course	Gal/Ton		
Permeable Asphalt Drainage Course, Type _____	Gal/Ton		
Sand Asphalt Surface Course, Type _____	Gal/Ton		

If the Contractor does not mark either Fuel Usage Factor or marks both Fuel Usage Factors for an asphalt item description, the 2.90 Fuel Usage Factor shall be used for that asphalt line item.

Signature, Title

Dated

Print Name, Title



STATE OF NORTH CAROLINA
DEPARTMENT OF TRANSPORTATION

LETTER OF INTENT TO PERFORM AS A SUBCONTRACTOR

CONTRACT:

NAME OF BIDDER:

The undersigned intends to perform work in connection with the above contract upon execution of the bid and subsequent award of contract by the Board of Transportation as:

Name of MBE/WBE/DBE Subcontractor _____

Address _____

City _____ State _____ Zip _____

Please check all that apply:

Minority Business Enterprise (MBE) _____

Women Business Enterprise (WBE) _____

Disadvantaged Business Enterprise (DBE) _____

The MBE /WBE /DBE status of the above named subcontractor is certified by the North Carolina Department of Transportation. The above named subcontractor is prepared to perform the described work listed on the attached MBE/WBE/DBE Commitment Items sheet, in connection with the above contract upon execution of the bid and subsequent award of contract by the Board of Transportation. The above named subcontractor is prepared to perform the described work at the estimated Commitment Total for Subcontractor Price identified on the MBE/WBE/DBE Commitment Items sheet and amount indicated below.

Commitment Total based on estimated Unit Prices and Quantities on the "attached" MBE/WBE/DBE Commitment Items sheet. Amount \$ _____

The above named bidder and subcontractor mutually accepts the Commitment Total estimated for the Unit Prices and Quantities. This commitment total is based on estimated quantities only and most likely will vary up or down as the project is completed. Final compensation will be based on actual quantities of work performed and accepted during the pursuance of work. The above listed amount represents the entire dollar amount quoted based on these estimated quantities. No conversations, verbal agreements, and/or other forms of non-written representations shall serve to add, delete, or modify the terms as stated.

This document shall not serve in any manner as an actual subcontract between the two parties. A separate subcontractor agreement will describe in detail the contractual obligations of the bidder and the MBE/WBE/DBE subcontractor.

Affirmation

The above named MBE/ WBE/ DBE subcontractor affirms that it will perform the portion(s) of the contract for the estimated dollar value as stated above.

Name of MBE/ WBE/ DBE Subcontractor

Name of Bidder

Signature / Title

Signature / Title

Date

Date

State of North Carolina
Department of Transportation
Subcontractor Payment Information

Submit with Invoice To: Division 12 Office
North Carolina Department of Transportation
1710 E. Marion St.
Shelby, NC 28150

Firm Invoice No. Reference
NCDOT PO / Contract Number
WBS No. (State Project No.)
Date of Invoice
Signed

Table with 7 columns: Invoice Line Item Reference, Payer Name, Payer Federal Tax Id, Subcontractor / Subconsultant / Material Supplier Name, Subcontractor / Subconsultant / Material Supplier Federal Tax Id, Amount Paid To Subcontractor / Subconsultant / Material Supplier This Invoice, Date Paid To Subcontractor / Subconsultant / Material Supplier This Invoice. Includes a total row for 'Total Amount Paid to Subcontractor Firms'.

NOTE: - These documents are scanned into our Fiscal program. Please do not highlight or shade the figures.

I certify that this information accurately reflects actual payments made and the dates the payments were made to Subcontractors/ Subconsultants/Material Suppliers on the above referenced project.

Signature _____

Title _____

ADDENDUM(S)

ADDENDUM #1

I, _____
(SIGNATURE)

representing _____

Acknowledge receipt of Addendum #1.

ADDENDUM #2

I, _____
(SIGNATURE)

representing _____

Acknowledge receipt of Addendum #2.

ADDENDUM #3

I, _____
(SIGNATURE)

representing _____

Acknowledge receipt of Addendum #3.

AWARD LIMITS ON MULTIPLE PROJECTS

It is the desire of the Proposer to be awarded contracts, the value of which will not exceed a total of \$ _____, for those projects indicated below on which bids are being opened on the same date as shown in the Proposal Form. Individual projects shall be indicated by placing the project number and county in the appropriate place below. Projects not selected will not be subject to an award limit.

(Project Number)

(County)

(Project Number)

(County)

(Project Number)

(County)

(Project Number)

(County)

*If a Proposer desires to limit the total amount of work awarded to him in this letting, he shall state such limit in the space provided above in the second line of this form.

It is agreed that in the event that I am (we are) the successful bidder on indicated projects, the total value of which is more that the above stipulated award limits, the Board of Transportation will award me (us) projects from among those indicated which have a total value not exceeding the award limit and which will result in the best advantage to the Department of Transportation.

**Signature of Authorized Person

**Only those persons authorized to sign bids under the provisions of Subarticle 102-8(A)(8) shall be authorized to sign this form.

EXECUTION OF BID

NON-COLLUSION, DEBARMENT AND GIFT BAN CERTIFICATION

CORPORATION

The prequalified bidder, declares (or certifies, verifies, or states) under penalty of perjury under the laws of the United States that neither he, nor any official, agent or employee has entered into any agreement, participated in any collusion, or otherwise taken any action which is in restraint of free competitive bidding in connection with any bid or contract, that the prequalified bidder has not been convicted of violating *N.C.G.S. §133-24* within the last three years, and that the prequalified bidder intends to do the work with his own bona fide employees or subcontractors and will not bid for the benefit of another contractor.

By submitting this non-collusion, debarment and gift ban certification, the Contractor is attesting his status under penalty of perjury under the laws of the United States in accordance with the Debarment Certification attached, provided that the Debarment Certification also includes any required statements concerning exceptions that are applicable.

N.C.G.S. §133-32 and Executive Order 24 prohibit the offer to, or acceptance by, any State Employee of any gift from anyone with a contract with the State, or from any person seeking to do business with the State. By execution of any response in this procurement, you attest, for your entire organization and its employees or agents, that you are not aware that any such gift has been offered, accepted, or promised by any employees of your organization.

SIGNATURE OF PREQUALIFIED BIDDER

_____ Full name of Corporation

_____ Address as Prequalified

Attest _____ By _____
Secretary/Assistant Secretary President/Vice President/Assistant Vice President
(Select appropriate title) (Select appropriate title)

_____ Print or type Signer's name _____ Print or type Signer's name

CORPORATE SEAL

NON-COLLUSION, DEBARMENT AND GIFT BAN CERTIFICATION

PARTNERSHIP

The prequalified bidder, declares (or certifies, verifies, or states) under penalty of perjury under the laws of the United States that neither he, nor any official, agent or employee has entered into any agreement, participated in any collusion, or otherwise taken any action which is in restraint of free competitive bidding in connection with any bid or contract, that the prequalified bidder has not been convicted of violating *N.C.G.S. § 133-24* within the last three years, and that the prequalified bidder intends to do the work with its own bona fide employees or subcontractors and will not bid for the benefit of another contractor.

By submitting this non-collusion, debarment and gift ban certification, the Contractor is attesting his status under penalty of perjury under the laws of the United States in accordance with the Debarment Certification attached, provided that the Debarment Certification also includes any required statements concerning exceptions that are applicable.

N.C.G.S. § 133-32 and Executive Order 24 prohibit the offer to, or acceptance by, any State Employee of any gift from anyone with a contract with the State, or from any person seeking to do business with the State. By execution of any response in this procurement, you attest, for your entire organization and its employees or agents, that you are not aware that any such gift has been offered, accepted, or promised by any employees of your organization.

SIGNATURE OF PREQUALIFIED BIDDER

Full Name of
Partnership

Address as Prequalified

Signature of Witness

Signature of Partner

Print or Type Signer's Name

Print or Type Signer's Name

NON-COLLUSION, DEBARMENT AND GIFT BAN CERTIFICATION

LIMITED LIABILITY COMPANY

The prequalified bidder, declares (or certifies, verifies, or states) under penalty of perjury under the laws of the United States that neither he, nor any official, agent or employee has entered into any agreement, participated in any collusion, or otherwise taken any action which is in restraint of free competitive bidding in connection with any bid or contract, that the prequalified bidder has not been convicted of violating *N.C.G.S. § 133-24* within the last three years, and that the prequalified bidder intends to do the work with its own bona fide employees or subcontractors and will not bid for the benefit of another contractor.

By submitting this non-collusion, debarment and gift ban certification, the Contractor is attesting his status under penalty of perjury under the laws of the United States in accordance with the Debarment Certification attached, provided that the Debarment Certification also includes any required statements concerning exceptions that are applicable.

N.C.G.S. § 133-32 and Executive Order 24 prohibit the offer to, or acceptance by, any State Employee of any gift from anyone with a contract with the State, or from any person seeking to do business with the State. By execution of any response in this procurement, you attest, for your entire organization and its employees or agents, that you are not aware that any such gift has been offered, accepted, or promised by any employees of your organization.

SIGNATURE OF PREQUALIFIED BIDDER

Full Name of Firm

Address as Prequalified

Signature of Witness

Signature of Member/Manager/Authorized Agent
(*Select appropriate Title*)

Print or Type Signer's Name

Print or Type Signer's Name

NON-COLLUSION, DEBARMENT AND GIFT BAN CERTIFICATION

JOINT VENTURE (2) or (3)

The prequalified bidder, declares (or certifies, verifies, or states) under penalty of perjury under the laws of the United States that neither he, nor any official, agent or employee has entered into any agreement, participated in any collusion, or otherwise taken any action which is in restraint of free competitive bidding in connection with any bid or contract, that the prequalified bidder has not been convicted of violating *N.C.G.S. § 133-24* within the last three years, and that the prequalified bidder intends to do the work with its own bona fide employees or subcontractors and will not bid for the benefit of another contractor.

By submitting this non-collusion, debarment and gift ban certification, the Contractor is attesting his status under penalty of perjury under the laws of the United States in accordance with the Debarment Certification attached, provided that the Debarment Certification also includes any required statements concerning exceptions that are applicable.

N.C.G.S. § 133-32 and Executive Order 24 prohibit the offer to, or acceptance by, any State Employee of any gift from anyone with a contract with the State, or from any person seeking to do business with the State. By execution of any response in this procurement, you attest, for your entire organization and its employees or agents, that you are not aware that any such gift has been offered, accepted, or promised by any employees of your organization.

SIGNATURE OF PREQUALIFIED BIDDER

Instructions: **2 Joint Venturers** Fill in lines (1), (2) and (3) and execute. **3 Joint Venturers** Fill in lines (1), (2), (3) and (4) and execute. On Line (1), fill in the name of the Joint Venture Company. On Line (2), fill in the name of one of the joint venturers and execute below in the appropriate manner. On Line (3), print or type the name of the other joint venturer and execute below in the appropriate manner. On Line (4), fill in the name of the third joint venturer, if applicable and execute below in the appropriate manner.

(1) _____
Name of Joint Venture

(2) _____
Name of Contractor

Address as Prequalified

Signature of Witness or Attest

BY

Signature of Contractor

Print or Type Signer's Name

AND

Print or Type Signer's Name

If Corporation, affix Corporate Seal

(3) _____
Name of Contractor

Address as Prequalified

Signature of Witness or Attest

BY

Signature of Contractor

Print or Type Signer's Name

AND

Print or Type Signer's Name

If Corporation, affix Corporate Seal

(4) _____
Name of Contractor

Address as Prequalified

Signature of Witness or Attest

BY

Signature of Contractor

Print or Type Signer's Name

AND

Print or Type Signer's Name

If Corporation, affix Corporate Seal

NON-COLLUSION, DEBARMENT AND GIFT BAN CERTIFICATION

INDIVIDUAL DOING BUSINESS UNDER A FIRM NAME

The prequalified bidder, declares (or certifies, verifies, or states) under penalty of perjury under the laws of the United States that neither he, nor any official, agent or employee has entered into any agreement, participated in any collusion, or otherwise taken any action which is in restraint of free competitive bidding in connection with any bid or contract, that the prequalified bidder has not been convicted of violating *N.C.G.S. § 133-24* within the last three years, and that the prequalified bidder intends to do the work with its own bona fide employees or subcontractors and will not bid for the benefit of another contractor.

By submitting this non-collusion, debarment and gift ban certification, the Contractor is attesting his status under penalty of perjury under the laws of the United States in accordance with the Debarment Certification attached, provided that the Debarment Certification also includes any required statements concerning exceptions that are applicable.

N.C.G.S. § 133-32 and Executive Order 24 prohibit the offer to, or acceptance by, any State Employee of any gift from anyone with a contract with the State, or from any person seeking to do business with the State. By execution of any response in this procurement, you attest, for your entire organization and its employees or agents, that you are not aware that any such gift has been offered, accepted, or promised by any employees of your organization.

SIGNATURE OF PREQUALIFIED BIDDER

Name of Prequalified Bidder

Individual Name

Trading and Doing Business As

Full name of Firm

Address as Prequalified

Signature of Witness

Signature of Prequalified Bidder, Individual

Print or Type Signer's Name

Print or Type Signer's Name

NON-COLLUSION, DEBARMENT AND GIFT BAN CERTIFICATION

Rev. 1-1-18

INDIVIDUAL DOING BUSINESS IN HIS OWN NAME

The prequalified bidder, declares (or certifies, verifies, or states) under penalty of perjury under the laws of the United States that neither he, nor any official, agent or employee has entered into any agreement, participated in any collusion, or otherwise taken any action which is in restraint of free competitive bidding in connection with any bid or contract, that the prequalified bidder has not been convicted of violating *N.C.G.S. § 133-24* within the last three years, and that the prequalified bidder intends to do the work with its own bona fide employees or subcontractors and will not bid for the benefit of another contractor.

By submitting this non-collusion, debarment and gift ban certification, the Contractor is attesting his status under penalty of perjury under the laws of the United States in accordance with the Debarment Certification attached, provided that the Debarment Certification also includes any required statements concerning exceptions that are applicable.

N.C.G.S. § 133-32 and Executive Order 24 prohibit the offer to, or acceptance by, any State Employee of any gift from anyone with a contract with the State, or from any person seeking to do business with the State. By execution of any response in this procurement, you attest, for your entire organization and its employees or agents, that you are not aware that any such gift has been offered, accepted, or promised by any employees of your organization.

SIGNATURE OF PREQUALIFIED BIDDER

Name of Prequalified Bidder _____
Print or Type Name

Address as Prequalified

Signature of Prequalified Bidder, Individually

Print or type Signer's Name

Signature of Witness

Print or type Signer's name

DEBARMENT CERTIFICATION

Conditions for certification:

1. The prequalified bidder shall provide immediate written notice to the Department if at any time the bidder learns that his certification was erroneous when he submitted his debarment certification or explanation filed with the Department, or has become erroneous because of changed circumstances.
2. The terms *covered transaction, debarred, suspended, ineligible, lower tier covered transaction, participant, person, primary covered transaction, principal, proposal, and voluntarily excluded*, as used in this provision, have the meanings set out in the Definitions and Coverage sections of the rules implementing Executive Order 12549. A copy of the Federal Rules requiring this certification and detailing the definitions and coverages may be obtained from the Contract Officer of the Department.
3. The prequalified bidder agrees by submitting this form, that he will not knowingly enter into any lower tier covered transaction with a person who is debarred, suspended, declared ineligible, or voluntarily excluded from participation in NCDOT contracts, unless authorized by the Department.
4. For Federal Aid projects, the prequalified bidder further agrees that by submitting this form he will include the Federal-Aid Provision titled *Required Contract Provisions Federal-Aid Construction Contract (Form FHWA PR 1273)* provided by the Department, without subsequent modification, in all lower tier covered transactions.
5. The prequalified bidder may rely upon a certification of a participant in a lower tier covered transaction that he is not debarred, suspended, ineligible, or voluntarily excluded from the covered transaction, unless he knows that the certification is erroneous. The bidder may decide the method and frequency by which he will determine the eligibility of his subcontractors.
6. Nothing contained in the foregoing shall be construed to require establishment of a system of records in order to render in good faith the certification required by this provision. The knowledge and information of a participant is not required to exceed that which is normally possessed by a prudent person in the ordinary course of business dealings.
7. Except as authorized in paragraph 6 herein, the Department may terminate any contract if the bidder knowingly enters into a lower tier covered transaction with a person who is suspended, debarred, ineligible, or voluntarily excluded from participation in this transaction, in addition to other remedies available by the Federal Government.

DEBARMENT CERTIFICATION

The prequalified bidder certifies to the best of his knowledge and belief, that he and his principals:

- a. Are not presently debarred, suspended, proposed for debarment, declared ineligible, or voluntarily excluded from covered transactions by any Federal department or agency;
- b. Have not within a three-year period preceding this proposal been convicted of or had a civil judgment rendered against them for commission of fraud or a criminal offense in connection with obtaining, attempting to obtain, or performing a public (Federal, State or local) transaction or contract under a public transaction; violation of Federal or State antitrust statutes or commission of embezzlement, theft, forgery, bribery, falsification or destruction of records; making false statements; or receiving stolen property;
- c. Are not presently indicted for or otherwise criminally or civilly charged by a governmental entity (Federal, State or local) with commission of any of the offenses enumerated in paragraph b. of this certification; and
- d. Have not within a three-year period preceding this proposal had one or more public transactions (Federal, State or local) terminated for cause or default.
- e. Will submit a revised Debarment Certification immediately if his status changes and will show in his bid proposal an explanation for the change in status.

If the prequalified bidder cannot certify that he is not debarred, he shall provide an explanation with this submittal. An explanation will not necessarily result in denial of participation in a contract.

Failure to submit a non-collusion and debarment certification will result in the prequalified bidder's bid being considered non-responsive.

Check here if an explanation is attached to this certification.

North Carolina Department of Transportation Division Contract Bid Form

WBS ELEMENT No.: 12.100211, 12.101811, 12.102311, 12.103611, 12.104911, 12.105511, 12.200211, 12.201811, 12.202311, 12.203611, 12.204911, & 12.205511

COUNTY(S): Alexander, Catawba, Cleveland, Gaston, Iredell & Lincoln

PROJECT DESCRIPTION Trenchless Installation of Welded Steel Pipe (Boring & Jacking), Upon Request

ITEM NO.	SECTION NO.	ITEM DESCRIPTION	QUANTITY	UNIT	UNIT PRICE	AMOUNT BID
1	SP	Emergency Mobilization	2	EA		
2	SP	Routine Mobilization	10	EA		
3	330	18" Welded Steel Pipe, 0.250" Thick, Grade B in Soil	50	LF		
4	330	18" Welded Steel Pipe, 0.250" Thick, Grade B Not in Soil	10	LF		
5	330	24" Welded Steel Pipe, 0.375" Thick, Grade B in Soil	50	LF		
6	330	24" Welded Steel Pipe, 0.375" Thick, Grade B Not in Soil	10	LF		
7	330	36" Welded Steel Pipe, 0.500" Thick, Grade B in Soil	50	LF		
8	330	36" Welded Steel Pipe, 0.500" Thick, Grade B Not in Soil	10	LF		
9	330	42" Welded Steel Pipe, 0.625" Thick, Grade B in Soil	50	LF		
10	330	42" Welded Steel Pipe, 0.625" Thick, Grade B Not in Soil	10	LF		
11	330	48" Welded Steel Pipe, 0.625" Thick, Grade B in Soil	100	LF		
12	330	48" Welded Steel Pipe, 0.625" Thick, Grade B Not in Soil	10	LF		
13	SP	Flowable Fill	25	CY		

NOTE: CONTRACT QUANTITIES ARE APPROXIMATE AND USED FOR DETERMINING THE LOWEST RESPONSIBLE BIDDER ONLY. NO MINIMUM OR MAXIMUM AMOUNT OF WORK IS GUARANTEED UNDER THIS CONTRACT.

TOTAL BID FOR PROJECT: \$ _____
--

CONTRACTOR: _____

ADDRESS: _____

_____ **PHONE:** _____

FEDERAL ID. No.	_____	CONTRACTOR LISC. No.	_____
AUTHORIZED AGENT	_____	TITLE	_____
SIGNATURE	_____	DATE	_____
WITNESS	_____	TITLE	_____
SIGNATURE	_____	DATE	_____

CORPORATE SEAL

Execution of Contract

Contract No: D12-12143762

County: Alexander, Catawba, Cleveland, Gaston, Iredell & Lincoln

ACCEPTED BY THE DEPARTMENT

Proposals Engineer

Date

**EXECUTION OF CONTRACT AND BONDS
APPROVED AS TO FORM:**

Division Engineer

Date

NORTH CAROLINA DEPARTMENT OF TRANSPORTATION PARTIAL JOINT PENETRATION JACK AND BORE WELDING PROCEDURE SPECIFICATION (WPS) AWS D1.1

Specifications & Codes: NCDOT Standard Specifications/AWS D1.1, Sections 2 thru 6

Material Specifications: ASTM A-36, A500, A529, A572, (A709-36, 50), (M270-GR250, 345) Unlimited Thickness

Welding Process: SMAW Manual or Semi- Automatic or Automatic: Manual

Filler Metal Specification: AWS A5.1 Classification: E-7018

Manufacturer: NCDOT Approved Electrodes Single or Multiple Pass both Position of Weld Flat, Horizontal, Vertical, Overhead

Welding Current: DC Polarity: Positive Progression: Vertical-up

Root Treatment: N/A

Preheat Temp: 100° minimum Interpass: 450° maximum Post Heat: N/A

Pass Num.	Electrode Size	Welding Current		Travel Speed	Position	Joint Details
		Amperes	Volts			
All	1/8" 5/32"	90-150 120-200	20-23 21-24	6-9 ipm 6-10 ipm	All All	SEE ATTACHMENTS

PREHEAT	
Thickness	Min. Temp.
Up to 3/4"	100°
Over 3/4" to 1 1/2"	100°
Over 1 1/2" to 2 1/2"	150°
Over 2 1/2"	225°

COMMENTS:

Remove all coating, rust, dirt and mill scale within one inch of the area to be welded. Remove all slag, spatter and weld discontinuities between passes. Clean the completed weld of all debris, slag and spatter.

WPS Description: PARTIAL JOINT PENETRATION Jack & Bore

Written By: Randy Dempsey, CWI/CWE, TT IV

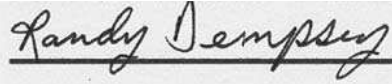
Signature: 

WPS #: 020612031

Authorized By: Steve Walton, Metals Engineer

Revision #: 1

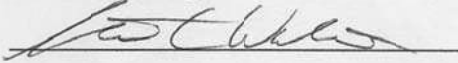
Signature: 

WPS SINGLE V GROOVE JACK & BORE 020612031 R1
JOINT DETAIL ATTACHMENT 1

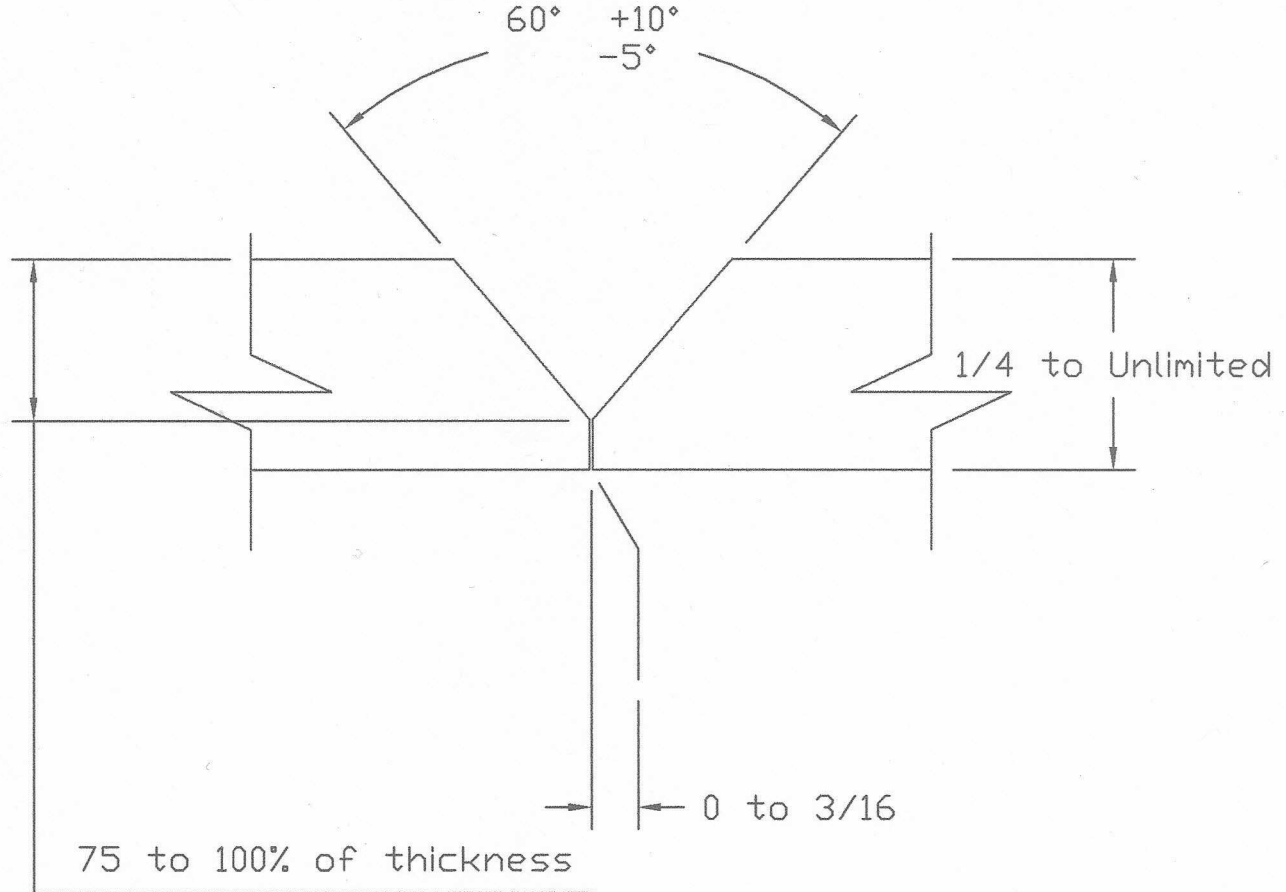

PARTIAL JOINT PENETRATION
Jack & Bore SINGLE V GROOVE
JOINT DETAILS

Weld Symbol definitions per AWS A2.4:2007

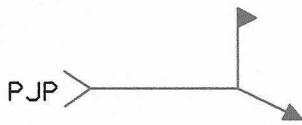

FIELD
WELD
SYMBOL

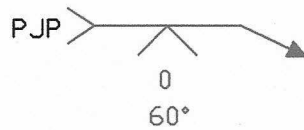

Single V Groove,
w/Root Opening and
Groove Angle

Illustrations for a partial joint penetration Jack & Bore.



Typical fit-up using a 45 degree Single Bevel.



Typical fit-up using a 60 degree Single V-groove.

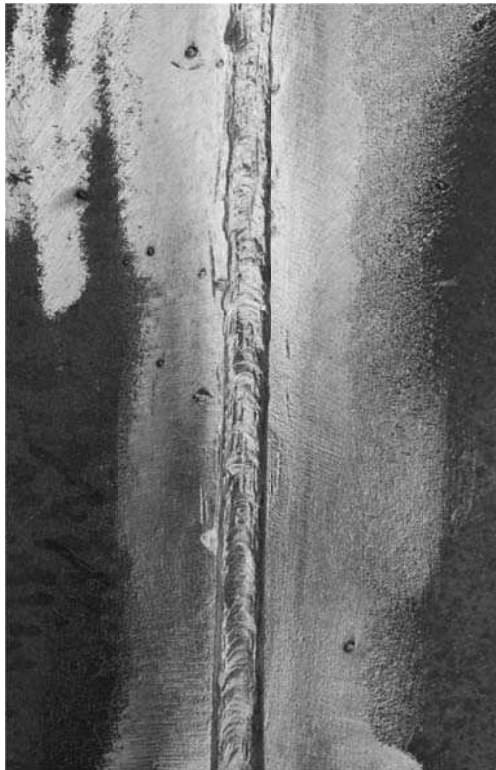

Typical appearance after cleaning first pass.

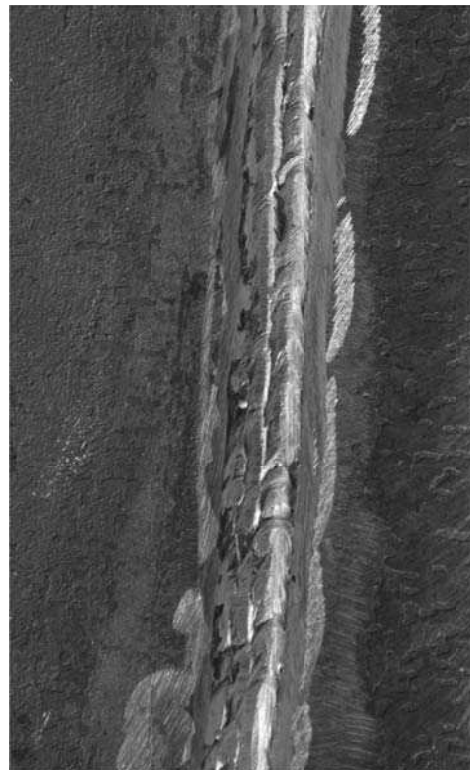

Completed weld

NCDOT MATERIALS & TESTS UNIT (STEEL SECTION)